



# Installation instructions, accessories

Volvo Car Corporation Gothenburg, Sweden

Instruction No	Version	Part. No.
31399122	1.0	31399121

## Diffuser, R-design



IMG-378183



# Installation instructions, accessories

Volvo Car Corporation Gothenburg, Sweden

## Equipment

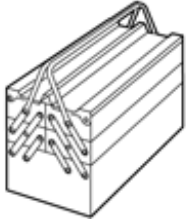

IMG-345497



IMG-378198



# Installation instructions, accessories

Volvo Car Corporation Gothenburg, Sweden

---

## Information

1

Read through all of the instructions before starting installation.

Notifications and warning texts are for your safety and to minimise the risk of something breaking during installation.

Ensure that all tools stated in the instructions are available before starting installation.

Certain steps in the instructions are only presented in the form of images. Explanatory text is also given for more complicated steps.

In the event of any problems with the instructions or the accessory, contact your local Volvo dealer.

---

## Further information

2

When installing, the car must retain a temperature of 20 degrees C.

---

## Color symbols

3

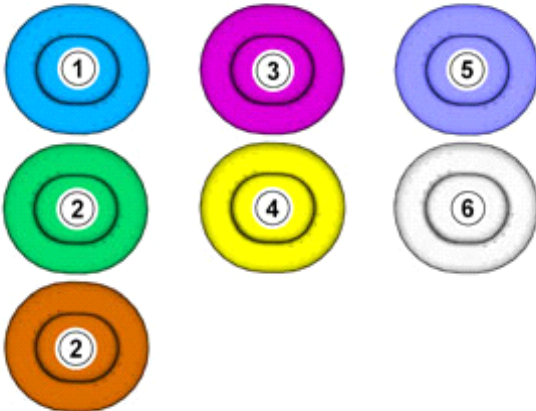

1. Used for focused component, the component with which you will do something.
2. Used as extra colors when you need to show or differentiate additional parts.
3. Used for attachments that are to be removed/installed. May be screws, clips, connectors, etc.
4. Used when the component is not fully removed from the vehicle but only hung to the side.
5. Used for standard tools and special tools.
6. Used as background color for vehicle components.

IMG-363036



# Installation instructions, accessories

Volvo Car Corporation Gothenburg, Sweden

4

Turn off the ignition.



IMG-245980

---

## Removal

---

5

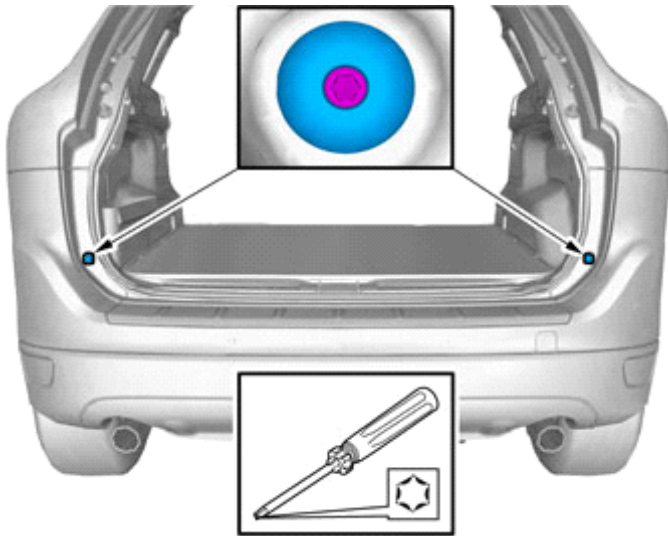

IMG-297185



# Installation instructions, accessories

Volvo Car Corporation Gothenburg, Sweden

6

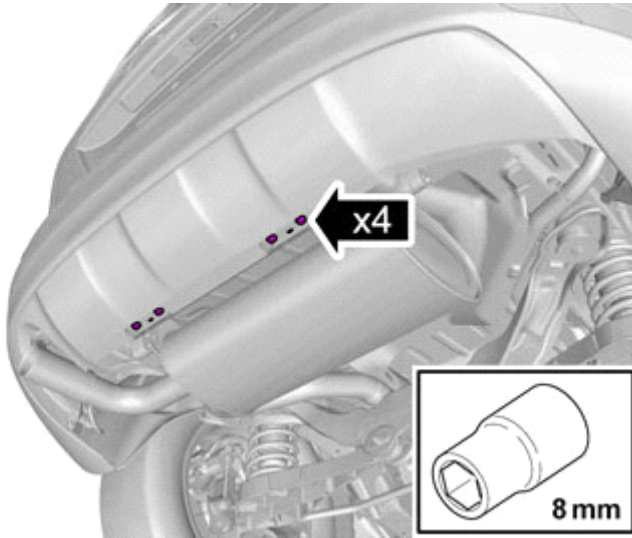

IMG-377456

Remove the screws.

7

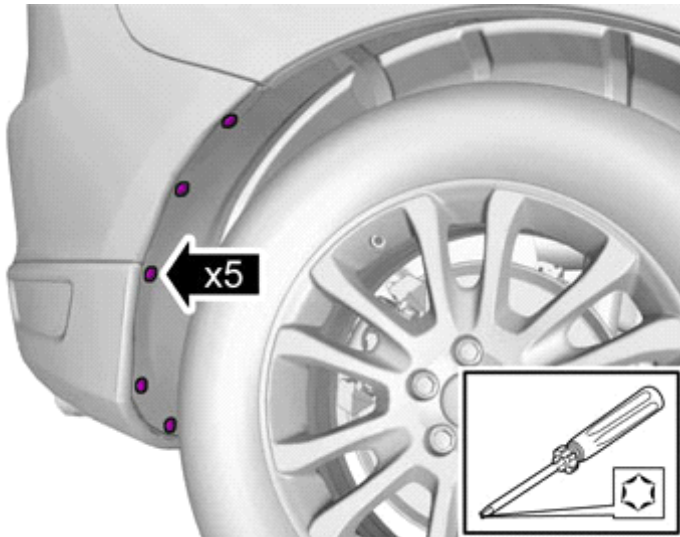

IMG-297503

Remove the screws.

On both sides.

8

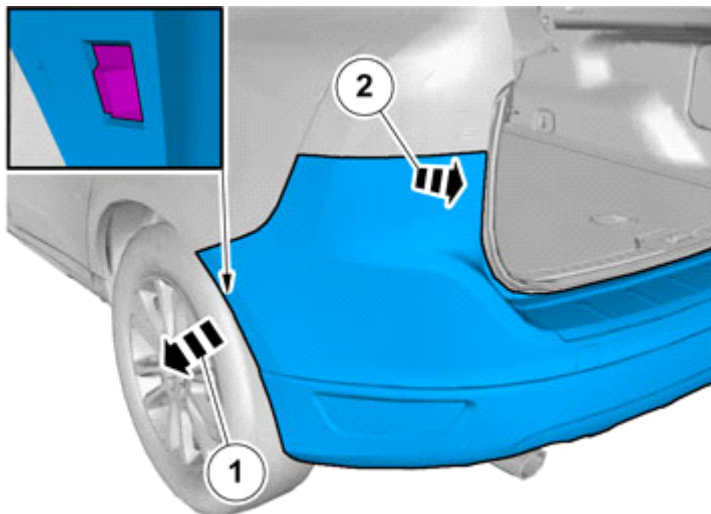

IMG-297504

**Note!**

This step is easier with two people.



# Installation instructions, accessories

Volvo Car Corporation Gothenburg, Sweden

9

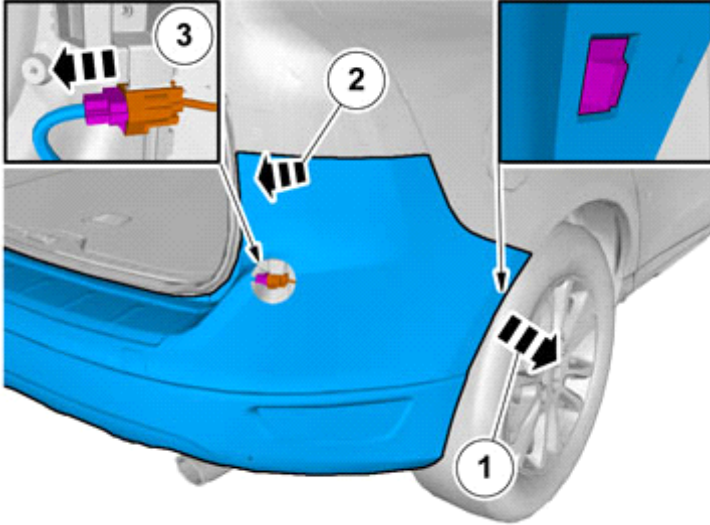

IMG-297523

**Note!**

This step is easier with two people.

Disconnect the connector.

10

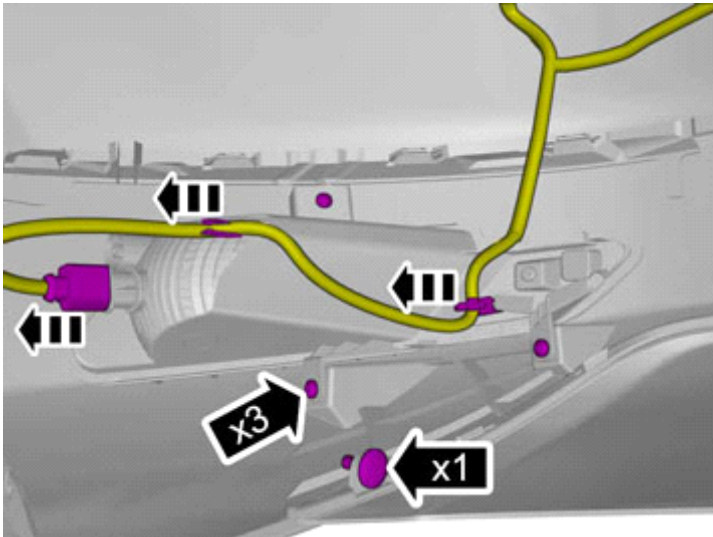

IMG-378187

On both sides.

Remove the cable harness clips.

Remove the screws.

11

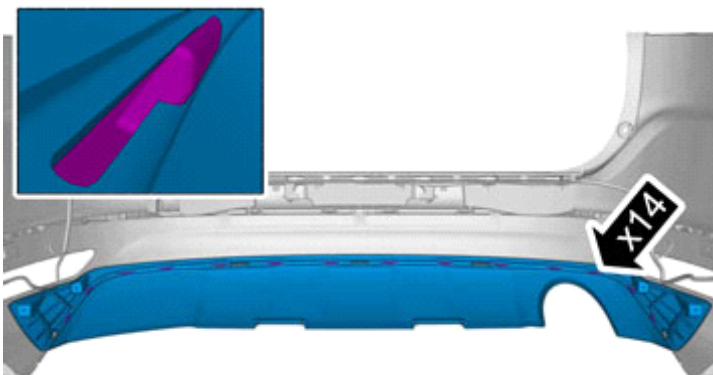

IMG-378185



# Installation instructions, accessories

Volvo Car Corporation Gothenburg, Sweden

12

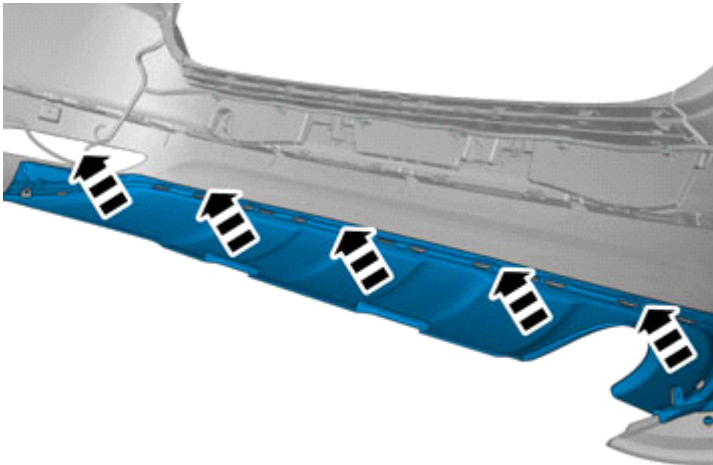

Remove the panel.

IMG-378186

## Accessory installation

13

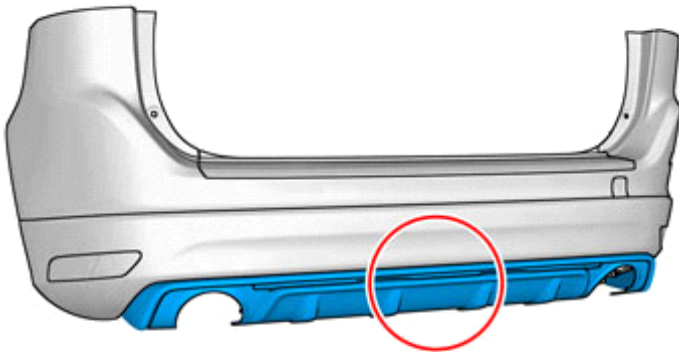

**Note!**  
Orientation view

IMG-377381

## Vehicles with detachable towbar





# Installation instructions, accessories

Volvo Car Corporation Gothenburg, Sweden

14

Locate relevant marking.

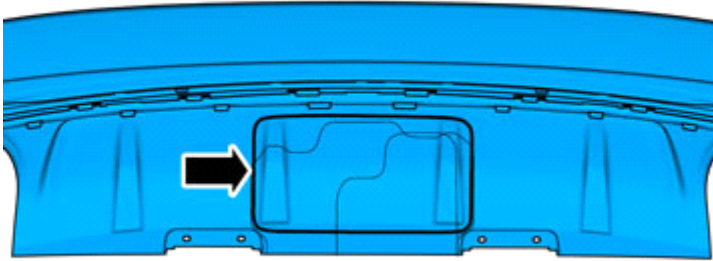

IMG-377732

15



Apply tape to the other side, opposite the marking lines.



IMG-377740

16

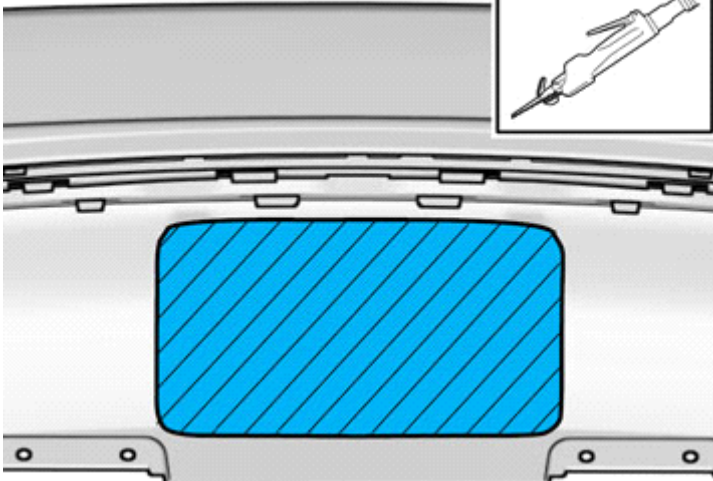
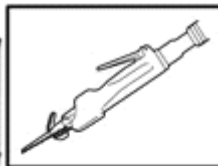

IMG-377750





# Installation instructions, accessories

Volvo Car Corporation Gothenburg, Sweden

17

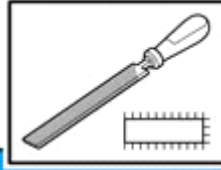

Deburr edges

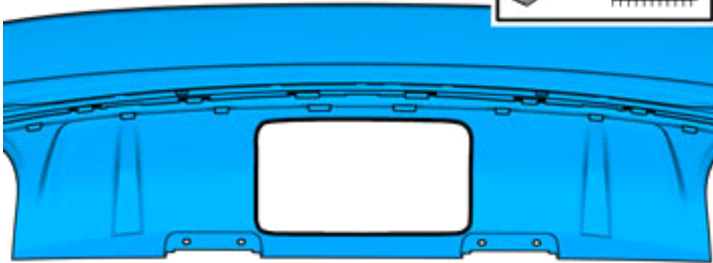

IMG-37752

**Vehicles with fixed towbar**

18

Locate relevant marking.

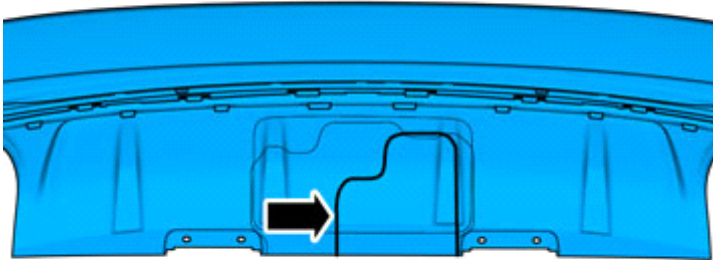

IMG-378000



# Installation instructions, accessories

Volvo Car Corporation Gothenburg, Sweden

19



Apply tape to the other side, opposite the marking lines.

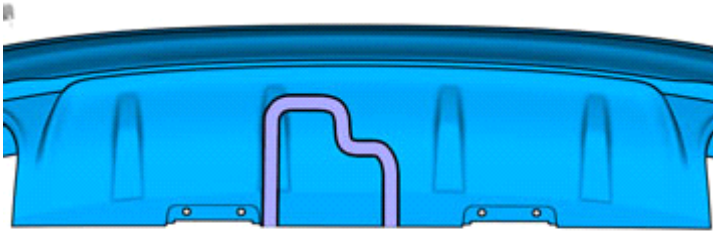

IMG-378001

20

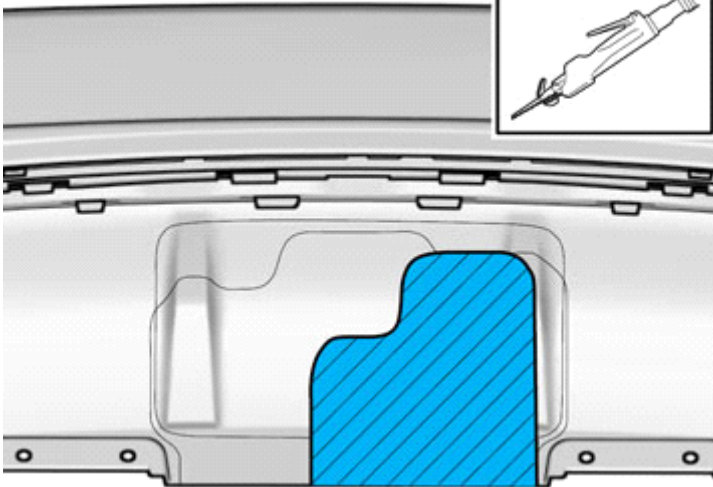
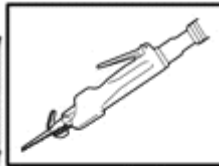

IMG-378003

21

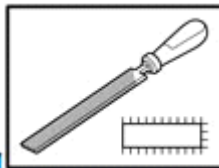

Deburr edges

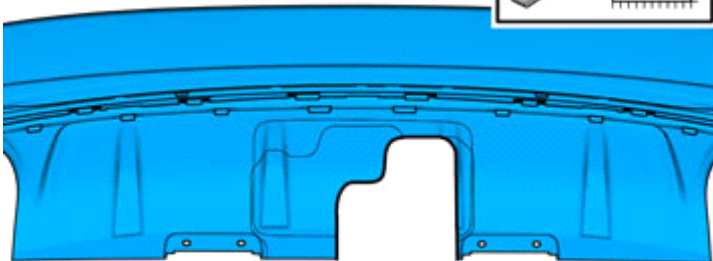

IMG-378004



All vehicles

22

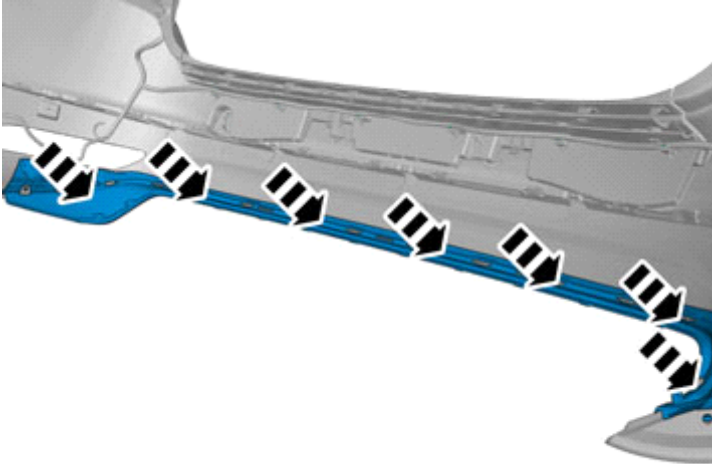

IMG-378188

23

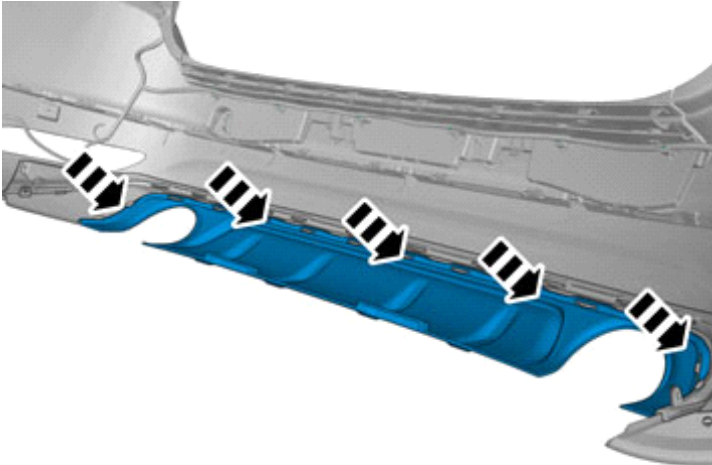

IMG-378189



# Installation instructions, accessories

Volvo Car Corporation Gothenburg, Sweden

24

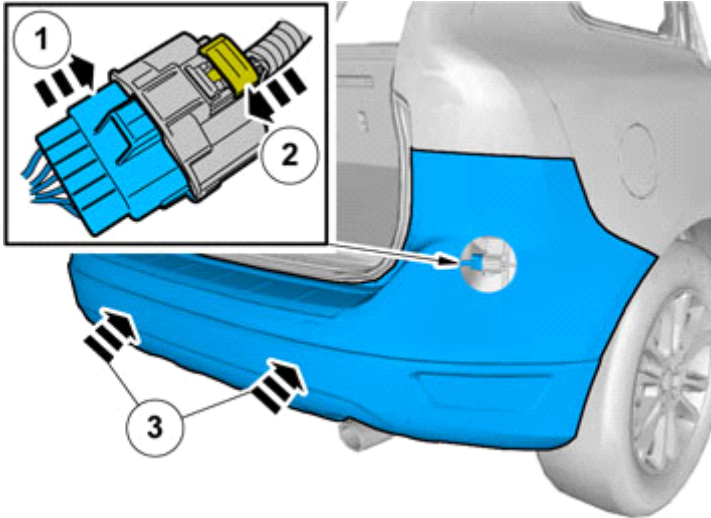

IMG-297604

25

Reinstall the removed parts in reverse order.